

Developers :
Altitude Lifespace Limited

PRADHAN ELARIS

Bs. Darshanam Club Life,
Opp. Vishranti 41, New Gotri, Vadodara.

M : +91 **88667 33660**

E : pradhandevelopments@gmail.com

Architect :



DESIGN STUDIO
architects & interiors
RUCHIR SHETH

Structure :



Plumbing :

*Krupalu
Consultant*

Electrical



PRADHAN ELARIS

4BHK PREMIUM FLATS





G+ 10 STOREY
residential towers

Thoughtfully Planned
4 BHK APARTMENTS

Located amidst the serene surroundings of
NEW GOTRI,

RISE HIGH TO AN ELEVATED LIFESTYLE

Experience elevated living in a seamless blend of sleek design and timeless aesthetics. Our residences are a symphony of sophistication and practicality, creating a vibrant urban canvas.

Amidst modern allure, a lush green campus unfolds, offering a tranquil sanctuary. Here, every detail converges to redefine contemporary living, where style meets nature in perfect harmony to gift you a life of your dreams.

VOUGE FASHION GIVENCHE CONVERGE COSMATICS LIFESTYLE PEPE JEANS REDTEPE DUSTON SPAL



GET A PERFECT COMBINATION
OF LUXURIOUS HOMES AND

20+ AMENITIES



Children's
Play Area



Senior Citizen
Sitting Area



Landscape
Garden



Multipurpose Hall



Swimming Pool



Toddler Room



Library



Infinity Water Fall

GROUND FLOOR PLAN



6.00 MT WIDE APPROACH

DN

6.00 MT WIDE APPROACH

18.00 MT WIDE ROAD

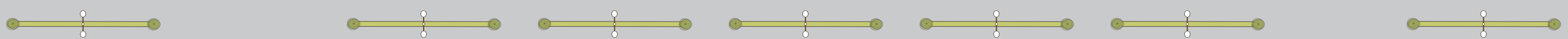
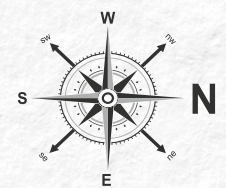

BASEMENT FLOOR PLAN

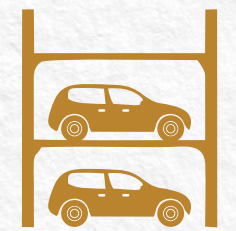
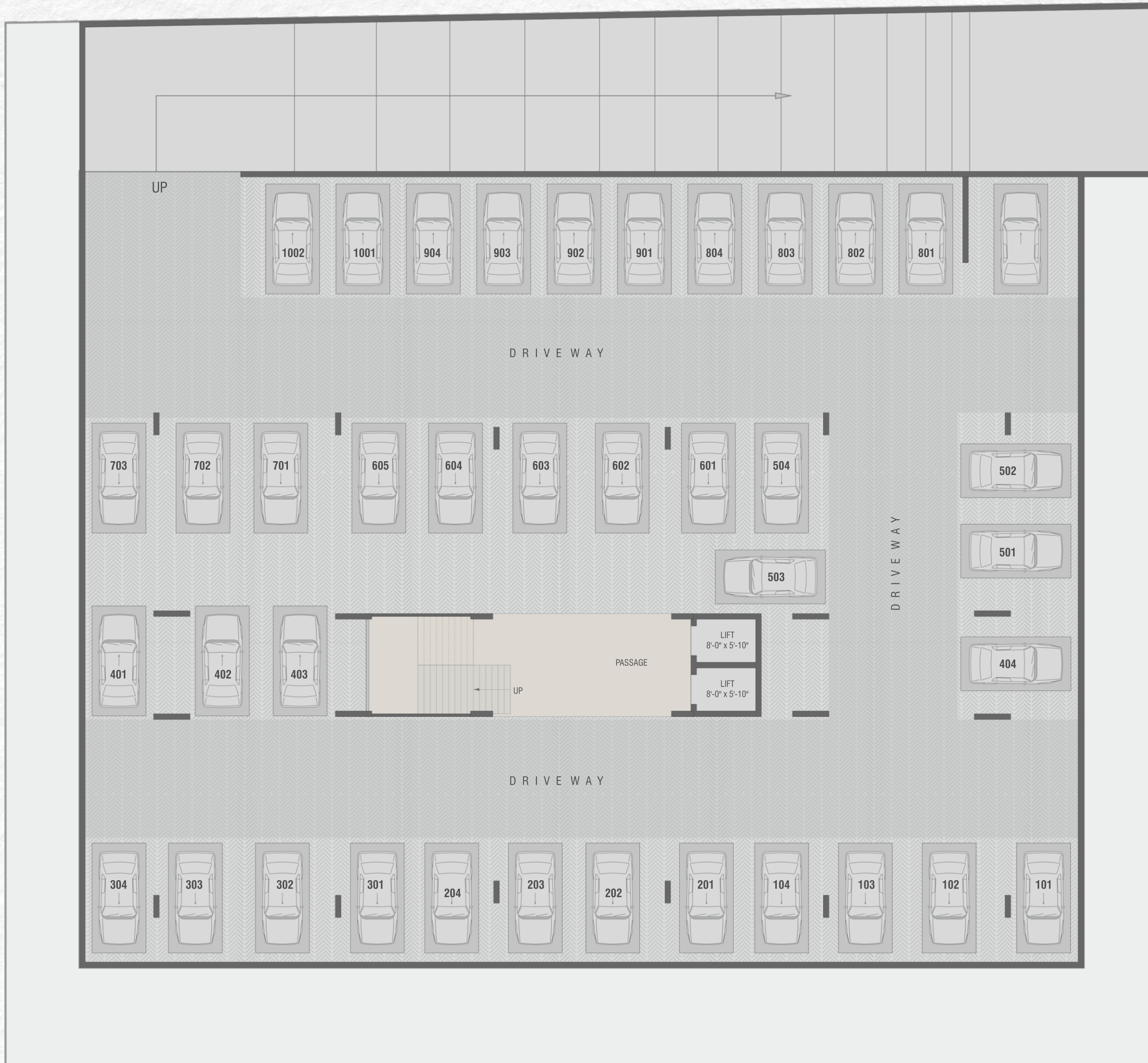

2 - Car
Stack Parking

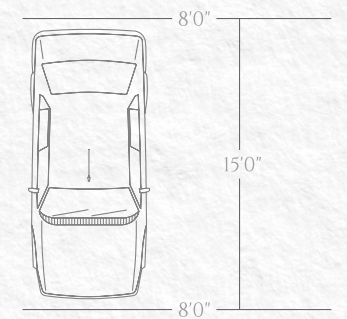
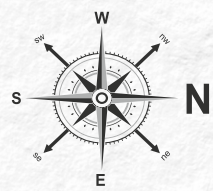

18.00 MT WIDE ROAD

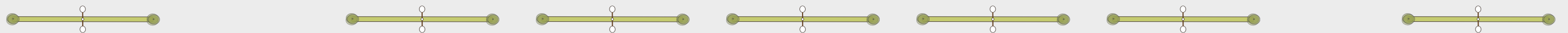

TYPICAL FLOOR PLAN

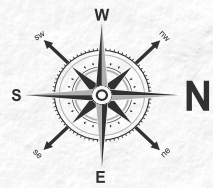

18.00 MT WIDE ROAD

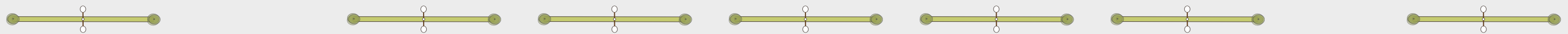





4 BHK FLOOR PLAN

1775
Built Up Area

2840
Super Built Up Area





-  Lounge Area
-  Gym
-  Gazebo
-  Yoga Desk
-  Jogging Track

TERRACE FLOOR PLAN

18.00 MT WIDE ROAD





VALUE ADDITION



2 Allotted
Car Parking



Name plate
& Letter Box



Standard
quality Lift



Elegant entrance gate
with security cabin



RCC trimix road with
designed street light



Rain water
Harvesting



Single Entry Campus
with 24x7 CCTV



Common Rooftop
Solar System



Fire Safety



Exterior wall finished with
rustic texture & apex ultima



Power backup through DG set for
lift, Passage & Parking Lights



Earthquake resistant RCC work
as per structure engineer design

Nature
Inspired

Innovative Design
Attributes

Thoughtful
Planning

Spacious
& Airy

Feature Rich
Amenities

Plush
Ambience





SPECIFICATIONS



STRUCTURE

- All RCC & Masonry work as per structural engineer's design.
- Elevation work as per Architect Design.



BATHROOMS

- Designer Glazed tiles Fitting
- Designer bathroom with premium quality fitting & vessels
- Concealed internal plumbing



PAINT & FINISH

- Internal : Smooth cement plaster with putty & primer
- External : Double coat plaster with acrylic paint for weather proof.



KITCHEN

- Granite Platform with Modern Sink & designer tiles



FLOORING

- Vitrified tiles flooring in all rooms.
- Granite / Tile flooring in stair case with railing.



DOORS & WINDOWS

- Attractive Entrance Door with Stone frames & standard quality safety lock
- Others are flush doors with stone frames
- Fully Glazed aluminum powder coated section windows.



ELECTRIFICATION

- Concealed copper ISI wiring & Branded modular switches with sufficient point in kitchen and all bedroom with ELCB switch for your family safety
- AC points in all bedrooms & living room.



WATER SUPPLY

- Underground & Overhead Water tank
- Submersible Pump with auto sensor
- 24x7 water supply through boring along with authority provision



TERRACE

- Open terrace finished with Brickbat water proofing and China Mosiac / Tiles Flooring



NEW GOTRI

**PRADHAN
GLENFOREST**



SEVASI

**PRADHAN
GLENWOODS**



BHAYLI

**YUG
SERENITY**

PAYMENT TERMS :

10% - Booking Amount | **10%** - Basement work on going | **10%** - Plinth Slab | **04%** - Ground Floor Slab
04% - on each slab (x10) | **05%** - on Brick work | **2.5%** - Outer Plaster | **2.5%** - On Internal Plaster
05% - on Flooring Work | **05%** - on Plumbing Fitting | **06%** - Before Sale Deed

TERMS AND CONDITION / DISCLAIMER :

(01) The Booking of the unit is confirmed only after receiving 30% of total cost, till then it will be treated as advance for allotted unit. (02) Possession will be given after one month of settlement of all account. Also vastupuja, furniture work will be permitted only after possession. (03) Development charges, Stamp duty, GST Common maintenance charges, Legal charges, MGVCCL, VMSS/VUDA charges will be paid by the purchaser. (04) Any new central or State Gov. Taxes, is applicable shall have to borne by purchaser. (05) Payment dues are to be paid within 7 days from the date of completion of each stage of work or as per commitment. (06) For delay in payment as per the above schedule, Interest as per RERA will be charges extra. If the due/committed payment is delayed continuously for more than 90 days, the developer reserves all rights to

cancel that booking by giving simple notice.(07) Developers shall have the right to change the plan, elevation, specification or extend the scheme or any details herein will be binding to all. (08) In case in the procedure or any activity of corporation/VUDA, MGVCCL or any authority shall be faced united. (09) Extra work shall be executed only after receiving full payment in advance-subject to approval. (10) Any kind of alteration or change is strictly not allowed inside or outside of unit which affect the elevation or outer look or strength on the unit or project. (11) Any plans, specifications or information in this brochure cannot form legal part of an offer, contract or agreement. It is only depiction of the project. (12) All images shown are for Illustration purpose only. (13) All disputes are subject to Vadodara Jurisdiction.

CANCELLATION POLICY : Cancellation charges Rs. 1,00,000/-, if agreement for sale is executed then cancellation charges will be Rs. 2,20,000/-, refund of any sort will be given after new booking of same premise.